

www.holosun.com

HE509T-RD: A new, compact enclosed reflex sight with the option of a 2MOA dot only, or 2MOA dot with 32MOA circle-dot reticle. Employing new LED technology, the battery life of one CR1632 battery can last up to 50,000 hours. The sight may be installed on various firearms such as shotguns, pistols, rifles, air rifles and crossbows. Thank you for purchasing the HE509T-RD Reflex Sight, please read the User's Manual carefully.

### Important Notices

1. Ensure the firearm is unloaded and safe by removing all ammunition and magazines from the firearm and verify an empty chamber before installation and battery replacement.
2. Please keep the packaging should you need to make a warranty claim.

### Model

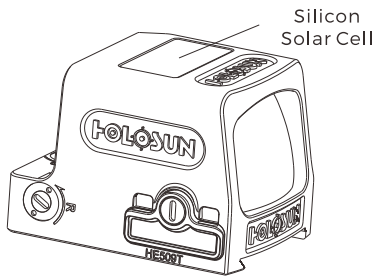

Fig1 HE509T-RD Reflex Sight

### Objective Lens

A canted objective lens is part of the design of reflex/reflective optical sights. In order to create a proper reflection of the

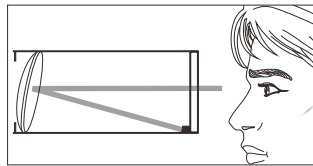

Fig2

reticle/dot the objective lens must be perpendicular to the LED. Because the LED is mounted near the base of the housing, the objective lens will be canted in that direction.

### Features

- 1) Automatic reticle intensity adjustment in Auto Mode
- 2) 2MOA dot only or 2MOA dot with 32MOA circle-dot
- 3) Shake Awake™ - Motion on with last setting recall
- 4) Parallax free, unlimited eye relief
- 5) Enclosed Design
- 6) Solid Titanium Body
- 7) 12 Brightness Settings: 10DL & 2NV
- 8) Window Size 0.63x0.91 inches
- 9) IP67 Waterproof and fog-proof

### Multi-reticle System

The default reticle for this sight is a 2MOA dot centered in a 32MOA circle with four positioning points.

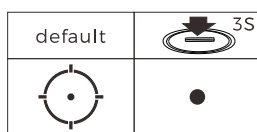

Fig 3

The diameter of the circle reticle represents approximately 32" at 100 yards (81cm at 100 meters). Hold the "-" button down 3 seconds to switch between the two reticle options (Circle-Dot and Dot only).

### Battery

1. The HE509T-RD operates with our Solar Fail Safe™ dual power system (solar cell and internal battery). One high quality CR1632 Lithium battery is included with purchase.
2. A high quality battery can power this device for up to 12,000 hours (circle-dot), or 50,000 hours (dot-only) at setting 6. Caution: Do not use a rechargeable battery.
3. Battery replacement (fig 4):
  - a. Remove the battery :
    - i. Loosen and remove the battery tray screw .
    - ii. Insert the included flat driver tool into one of the slots on top of the battery tray to assist in tray removal.
  - b. Battery installation :
    - i. Insert the battery into the battery tray making sure the positive / "+" side faces down in the tray.
    - ii. Insert and press the tray into the battery compartment.
    - iii. Tighten the battery tray screw to 6 in.lbs.

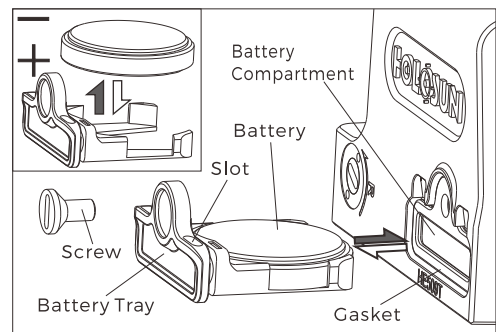

Fig 4

Caution: Loss or damage to the battery tray gasket may cause water to leak into the compartment which could damage the product.

### Installation

1. The HE509T is compatible with an industry standard mounting interface using the included mounting plate.

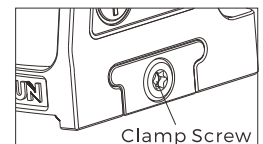

Fig 5-1

2. (Fig5-2) Use the two included 6-32 T10 flat head screws to attach the mounting plate to an industry standard mounting interface. Tighten the screws to 15 in/lbs.

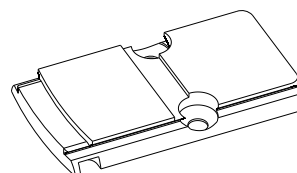

Fig 5-2

3. (Fig5-1) Use a T10 Torx tool (included) to loosen the clamp screw, then attach the HE509T onto the plate so the recoil lug engages the slot on the plate. Apply forward pressure and tighten to 20 inch/lbs.

## Sight operation

Two operation modes are available: Auto mode and manual mode. See Fig 6.

1. Power ON: Press and release either brightness button ("+" or "-") to turn on the sight.

2. Power OFF: Press the "+" and "-" buttons simultaneously to turn the power and motion sensor off.

Press and Hold the "-" button for 3 seconds to switch reticle between dot and circle dot.

3. Operation Mode: Three modes are available in the following order: Auto Mode -> Manual Mode -> Lockout Mode. See Fig 6.

1) Auto mode - operates with a solar cell and internal battery two-way power supply. Based upon the ambient lighting level, the sight will switch between battery and solar cell power automatically. Accommodates operation in all lighting conditions. Auto mode is the default setting.

a) In auto mode, the brightness of the reticle is automatically adjusted to match ambient lighting.

b) The battery will compensate for power if the solar cell cannot drive the reticle alone.

c) If lighting is low enough, the sight will automatically switch to battery power. While running on battery power, you can adjust the reticle brightness using the "+" and "-" buttons to switch between higher and lower brightness levels.

2) Manual mode:

a) Switch to Manual mode from Auto mode by holding the "+" button for about 3 seconds, until the reticle blinks once.

b) Brightness adjustment: There are 12 reticle brightness setting levels in manual mode. Settings 1 and 2 are NV compatible and setting 12 is the brightest. Press "+" or "-" to increase or decrease the brightness.

3) Lockout Mode:

Switch to Lockout mode from Manual mode by holding the "+" button for about 3 seconds, until the LED blinks once. In lockout mode, momentary presses of the "+" or "-" button will not change settings. To exit the lockout mode, press and hold the + button again for 3 seconds, the LED will blink once then switch to Auto Mode.

4. Sleep Timer Setting

1) Please note that the HE509T will automatically enter into sleep mode after 10 minutes of no movement.

2) The HE509T will instantaneously wake up and turn on to the last saved setting when any motion is detected.

3) The default sleep timer setting is 10 min, but can be adjusted.

i. Press and hold the "+" button for 10 seconds to enter sleep timer adjustment mode. There are 4 options: 10 min, 1h, 12h or the sleep mode is disabled.

ii. Press and release either "+" or "-" button to set the time. The LED will blink as follows: 1=10 min, 2=1h, 3=12h, or 4=disable sleep mode.

iii. Press the "+" and "-" buttons simultaneously to save the time setting and power off the sight.

5. Note:

1) Memory function: The sight will remember the last saved brightness setting when powered on and off.

2) Low battery Warning: If the battery voltage is below 2.2Vdc, the reticle will blink slowly.

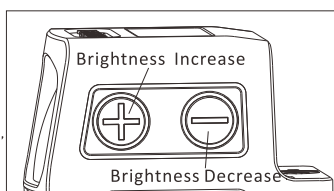

Fig6

## Zero setting

1) This sight has been factory adjusted to an approximate 25 yard zero and should require minimal adjustment to zero.

2) The Elevation adjustment is located on top of the tail section of the housing and the Windage adjustment is located on the right side of the housing. Adjustment can be performed by inserting the included flat driver tool into the turret slot and rotating. See Fig 7.

3) Windage and Elevation adjustments are approximately 1 MOA per click.

4) Each adjustment click has a value of approximately 1 MOA or 1 inch at 100 yards (1/2" at 50y; 1/4" at 25y). When zeroing at 25 yards, if your impacts are 2 inches low and 1 inch right, you will need to adjust Elevation 8 clicks UP (counter clockwise) and 4 clicks LEFT (clockwise)

5) The maximum adjustment range is  $\pm 50$ MOA.

Caution: If you feel the knobs can no longer be rotated, you may have reached the mechanical limit of the adjustment turret. Do not try to rotate the knobs further if you feel a bind or you may cause damage.

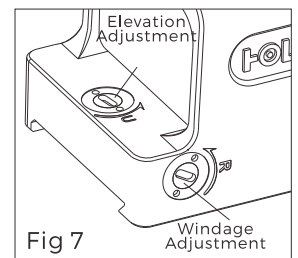

Fig 7

## Maintenance & care

This device is a precision instrument that deserves reasonably cautious care. The following tips are provided to ensure a long product life. The optical lenses are multicoated optical glass. When cleaning the lenses, blow away the dust on the surface, wet the lens with lens cleaner or clean water, then wipe away smudges with lens tissue, soft cotton or a microfiber cloth. Avoid touching the glass surface with dry cloth or tissue paper. Do not use organic solvents such as alcohol or acetone. No special maintenance is needed for the housing surface. Do not try to dismantle the device as the internal parts are specially cleaned and sealed and with an anti-fog treatment. Any such attempt will void the warranty.

## Limited warranty

We provide a limited lifetime warranty from the date of purchase on parts and workmanship to the original purchaser. At our sole discretion, we will repair or replace products found to be defective under normal use without charge, excluding any delivery costs, which will be born by purchaser. We will not be liable for incidental, consequential, or special damages arising out of or in any connection with the use or performance of this product. This warranty is void if the product has been misused, modified, neglected, or disassembled prior to its return. Please refer to [www.holosun.com](http://www.holosun.com) for current and complete warranty information and other conditions.

## HE509T-RD Reflex Sight

**HOLOSUN**  
Holosun Technologies Inc.  
[www.holosun.com](http://www.holosun.com)

### Customer Service

Phone: (909) 594-2888

Fax: (909) 598-4888

Email: [warranty@holosun.com](mailto:warranty@holosun.com)